











### SAFETY RULES

-  Do not connect the device to loads exceeding the permitted values.
-  Connect only in accordance with the diagram presented in the manual. Improper connections may be dangerous, it can damage the controller, and loss of the warranty.
-  **DANGER!** Risk of electric shock! Even with the device turned off, the outputs may be live. All assembly work should be ALWAYS performed with the disconnected power circuit.
-  The installation of the device to a power mains that does not meet the quality requirements defined by PN-EN 50160, will result in the loss of the warranty.
-  **ATTENTION!** The device is designed to operate in an electric network of 230V phase voltage and 400V phase-to-phase voltage. Take special care during installation!
-  The controller has been designed to work only with heating devices
-  To ensure protection against electric shock, the protective terminal of I class heating devices must always be connected to the protective earth (PE) terminal in the TN-S network or to the neutral-protective (PEN) terminal in the TN-C network. At the installation of electrical devices, special attention must be paid to the protection against electric shock described in PN-HD 603 64-4-41.
-  Connection of the controller must be carried out only by persons with the corresponding electrician license.
-  The controller must not be installed inside the sauna room.

GENERAL CONNECTION DIAGRAM

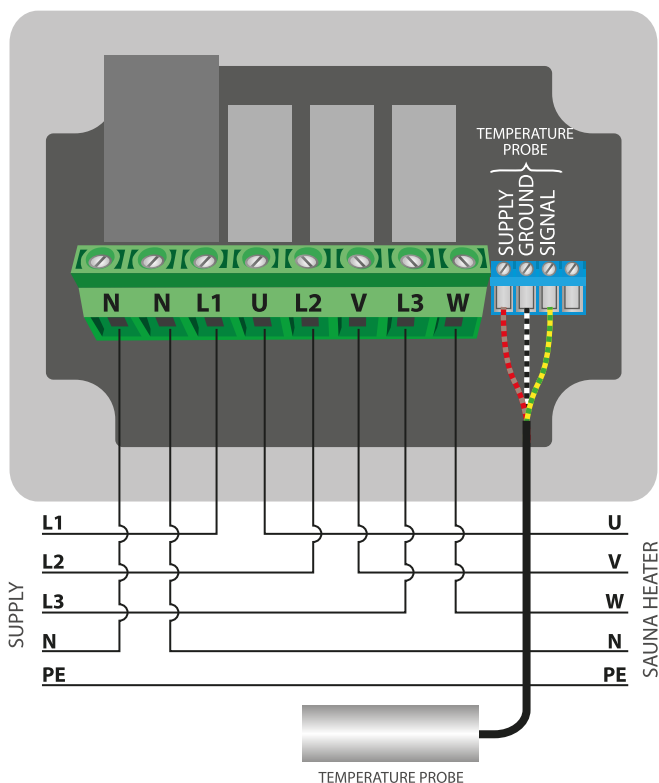

SINGLE PHASE SUPPLY, SINGLE PHASE HEATER

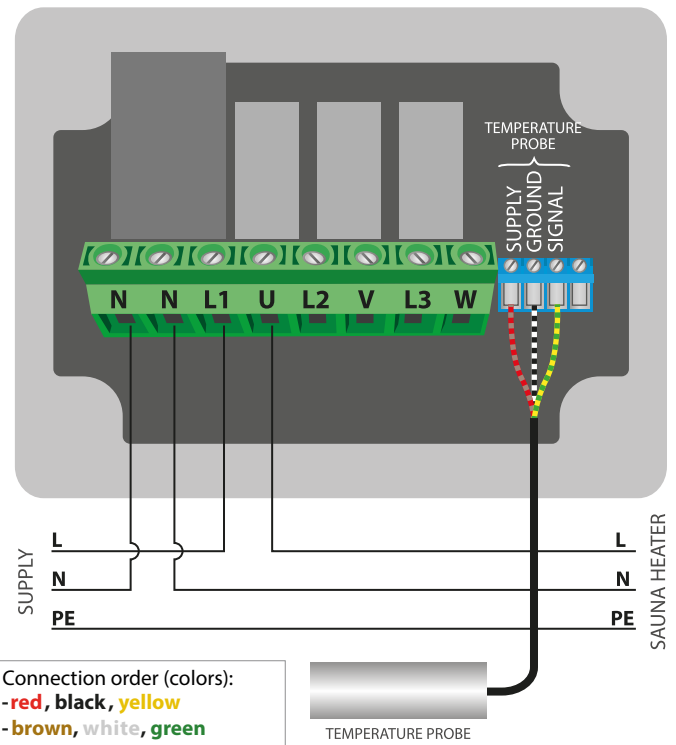

SINGLE PHASE SUPPLY, THREE PHASE HEATER IN STAR CIRCUIT

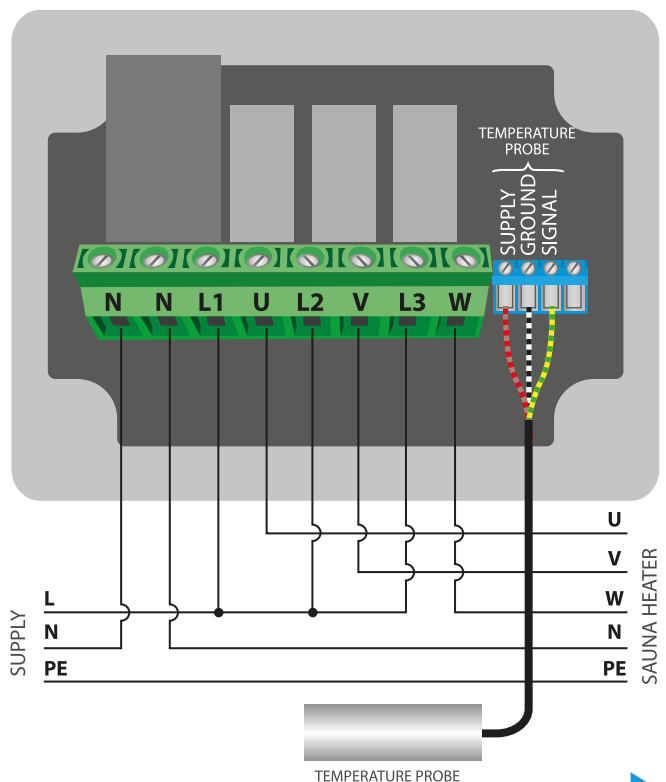

# 1

## INSTALLATION - BASICS

- Disconnect the supply before installing the controller. Remember that any mounting works should be carried out when the mains voltage is disconnected.
- The controller should be installed in a place protected against adverse environmental conditions. Remember that metallic elements (wires, tubes, housing parts) have a negative influence on the range of the device, and consequently the comfort of use. The controller and electric wires must be fixed permanently to the wall. Due to the operating voltage of the device it is necessary that the wires are inserted through the rubber glands and the cable insulation is cutted-out inside the controller housing at a distance of at least 1 cm from the cable gland. When connecting the wires, make sure that the insulation along the entire length of the wire is not damaged. The correct installation must guarantee that all conductive elements are protected against accidental contacts or short circuits, which may cause an electric shock or damage to the device.
- Read the diagram and then proceed to install the controller. Remove the four screws which fix the front panel of the controller and then, holding it on both sides, pull the panel toward you, which will disconnect the pin header connector. Pay special attention to the designation of the controller connectors. Start from connecting the power wires: phase L1 (brown), L2 (black), L3 (gray) and neutral N (blue). In the case of a single-phase power supply, connect the phase wire (brown) to the connector L1 (or to the bridged connectors L1, L2 and L3) and neutral wire (blue) to the connector N.
- Connect the heater, in a single-phase system to the U and N connectors. In a three-phase system, it is necessary to check in which configuration the heater must operate: star configuration (it is the most common) or delta (triangle) configuration. Connect the heater to the U, V, W and N connectors according to the system configuration. Remember to connect the protective wire PE (yellow-green).
- Connect the external temperature probe to the blue connector in the order of colors (from the left): red, black and yellow or brown, white and green. The last connector, on the far right, must be disconnected, it has been designed to allow the expansion of the capabilities of the product and is currently not used. It is not recommended to extend the original temperature probe cable since the induced interference can cause the controller malfunction or even its damage.
- Remove the pin header from the front panel and insert it into the socket in the controller. Holding the front panel on both sides, place it carefully and delicately on the controller housing, paying attention to the correct insertion of the header into the socket. Pay attention that the header does not move during the assembly of the panel. Carefully tighten the four screws that secure the front panel, taking care not to use too much force that could damage the housing material.
- After making sure that the device is connected according to the diagram and that the heater works in the correct circuit (star or delta) configuration, start the device by turning on the supply - the middle LED diode will light up the panel.

# 2

## FIRST START

- Download the **free wBox application**. If you have an Android mobile device, you will find the application in the Play Store. For iOS devices the application is in the App Store.
- By using your mobile phone or tablet, connect it to the device wireless network. To do this, enter to your smartphone or tablet settings, then go to setting of the WiFi network and find the network name „saunaBox-xxxxxxx“ where xxxxxxxx is the serial number of the device. Connect to this network.
- Turn on the wBox application. A device will appear at the top of the screen. To add it to the application, click on "plus" on the right side of the name. To preconfigure the controller, click on the default device name.



You can also set the configuration using the web browser of your phone / tablet. After connecting to the wireless network of the controller, turn on the browser and go website [www.blebox.eu](http://www.blebox.eu)

- Test the work of the controller by moving the ON / OFF button to the ON position or pressing the middle button of the keyboard panel - the controller will illuminate the panel and the LEDs of the temperature adjustment buttons will light up. In the ON position it is possible to adjust the desired temperature: in the application, move the temperature control scroll bar upwards or on the front panel keep pressed the button which increases the temperature. When the desired temperature exceed current temperature the controller will turn on the relays and heating will start. Observe the readings of measured temperature: the readings should increase at the same time as the room heats up and the panel backlight should change color.
- Go to settings ("Settings" icon in the upper right corner of the screen) to the "Sauna setting" section. In the fields "Minimum temperature" and "Maximum temperature", it is possible to change the operating range of the temperature controller. Limiting the operating range helps with the precise adjustment of the temperature using the setting scroll bar and the buttons on the keyboard panel. For example, in the case of a dry sauna, it is recommended to set the field "Minimum temperature" to 60°C and the field "Maximum temperature" to 110°C.

# 3

## ACCESS POINT AND WIFI NETWORK SETTINGS

- Once you turn on the controller for the first time, you can proceed to its further configuration. Being connected to the WiFi network emitted by the device, in the control panel of the wBox application select the device, then go to "Settings" (icon at the top-right corner of the screen).
- You can change the name of the device that is displayed in the wBox application. In addition, you can change the name and password of its generated WiFi network. Remember that changing the network name or password will disconnect the device immediately after you click the "Save" button, so re-connect to the device using the newly assigned network name and password.
- You can add the controller to your home WiFi network to control it through this home network or from anywhere in the World. To do this, in the "Connect" settings section, select a network name from the list and press "Connect". If is required, enter the WiFi network password. During the connection of the controller to your home network, the phone / tablet may be disconnected from the network. In this case, you will need to reconnect your phone / tablet to the controller network.
- Please remember that in order to control the device outside the local WiFi network, from anyplace in the World by using the wBox application, the option "Remote access enabled" in the controller settings must be set to "Yes".
- Once you've finished configuring the WiFi network, you can disconnect your phone/tablet from the controller network and connect your mobile device directly to your home WiFi network. The control from the wBox application will work the same way as when the phone / tablet is connected to the controller network. If the user leaves the local network, for example, leaving home or using the mobile data, the wBox application will signal this state as "Remote mode". In this case, the devices can be controlled, but for security reasons settings are not available.

## TECHNICAL SPECIFICATIONS

<b>power supply</b>	1x230V (single phase) or 3x230V (three phase)
<b>controller energy consumption</b>	< 1W (standby) < 2W (power on)
<b>number of outputs</b>	3



<b>type of outputs</b>	relay
<b>maximum load</b>	3 x 16A
<b>maximum power</b>	3 x 3680VA 3 x 3680W (for resistive load e.g. heater)
<b>galvanic isolation</b>	no
<b>number of buttons</b>	3
<b>buttons type</b>	capacitive (touch sensor), illuminated, integrated
<b>mounting method</b>	integrated in the front panel
<b>inputs type</b>	temperature probe
<b>measurement range</b>	from -55°C to 125°C
<b>measurement accuracy</b>	± 0,5°C in the range of -10°C to 85°C
<b>signaling on the housing</b>	colorful, illuminated front panel informing about the set temperature, current temperature, failure
<b>controller signaling</b>	blinking blue diagnostic diode (option to switch off in the controller settings)
<b>controller operating temperature</b>	from -20°C to 50°C
<b>housing</b>	surface junction box, controller covered with a polyurethane composition not containing halogens, self-extinguishing for thermal class B (130 °C)
<b>protection level</b>	IP44
<b>dimensions</b>	129 x 89 x 57 mm
<b>transmission type</b>	bi-directional, encrypted
<b>radio frequency</b>	2.4 GHz
<b>communication standard</b>	µWiFi, compatible with WiFi, 802.11g
<b>encryption</b>	WPA2-PSK and authenticated encryption with associated data (AEAD)
<b>mode</b>	direct connection (as Access Point), Wi-Fi connection via a standard router, connection with access from any location in the world (requires only access to the Internet)
<b>compatible devices and systems</b>	Apple iPhone, Apple iPad, iPad Mini, Android, computers and mobile devices supporting HTML5

## ADDITIONAL INFORMATION

### LOCATION AND TIME OF THE DEVICE, SCHEDULE

The controller has the ability to work according to a given schedule. To make this possible, set the device's time. Go to settings in the "Device time" section, click "Change timezone". Then select your region and location from the list, confirm your selection clicking the "Save" button. The device will synchronize its time with the server time (if the controller is in a WiFi network with access to Internet) or it will download time from the phone / tablet. It is recommended that the controller is always connected to a WiFi network with Internet access so that it can automatically synchronize its clock.

To be able to control devices using the local sunrise and sunset, you must also select the location of the controller. You can specify the location of the device using a smartphone or tablet. In the section "Device location", click "Set locations". Browser will ask whether to share locations - allow. In the "Coordinates" field, should appear the approximate coordinates of your location. If the "Set locations" button blinks red with the word "Error", or the "Coordinates" field did not change the value from "Not set" to numeric data, a failure has occurred during the location download. You should make sure that the phone / tablet has a GPS module and that the sharing location service is enabled on the phone.

Adding schedule entries can be performed by clicking the "Add item" button in the "Schedule" section of settings. You can select the days in which the task will be performed, the type of entry (at a specific time, or relative to sunrise / sunset - only having a correctly set location) and set the parameters of the task. The set tasks will be visible as a list, individual entries can be edited or deleted.

### SOFTWARE UPDATE

To update the software in the controller, connect it to your home WiFi network (see "Access Point and WiFi settings" section) which is connected to the Internet. Go to "Settings" (icon at the top-right corner of the screen) and click the "Get new firmware" button in the final section on settings. Wait about 1 minute, do not close the interface and don't perform other actions. The device will download the latest software. The software version number, hardware version and device identifier can be read at the bottom of the settings screen.

for more information  
visit our website

[www.blebox.eu](http://www.blebox.eu)

or send us an email to:  
info@blebox.eu

support is available at  
support@blebox.eu

made in europe



proudly made by  
**blebox**