







ability to control by voice commands with Amazon Alexa and Google Home



SAFETY RULES

-  Do not connect the device to loads exceeding the permitted values.
-  Connect only in accordance with the diagram presented in the manual. Improper connections may be dangerous, it can damage the controller, and loss of the warranty.
-  DANGER! Risk of electric shock! Even with the device turned off, the outputs may be live. All assembly work should be ALWAYS performed with the disconnected power circuit.
-  Connecting the device to a power supply that does not meet the quality requirements specified in EN 50081-1, EN 50082-1, UL508, EN 60950 will invalidate the warranty.

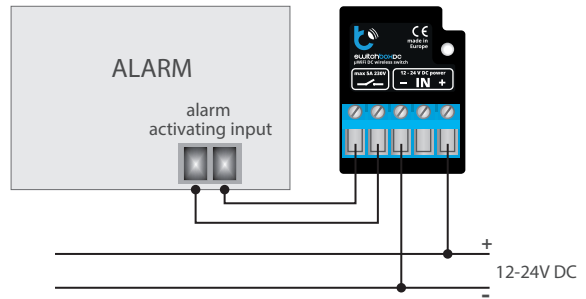

- The controller should be installed in a place protected against adverse environmental conditions, protected from third party access - in the flush box or inside the enclosure of the controlled device. It is recommended that the device be mounted in a stable and fixed position.
- Familiarize yourself with the diagram and then proceed with the installation of the controller. Pay special attention to the designation of the controller connectors. Start by connecting the power wires: +12/+24V (red or black with a white dotted line) and ground (black).
- Connect the load - polarity does not matter (isolated output). If you want a local control with a wall switch, connect the wall push-button according to the diagram. To control using only your phone or tablet, it is not necessary to install the wall push-button.
- After making sure that the device is connected in accordance with the diagram and that there are no metal components near the controller which may accidentally cause short-circuit, start the device by turning on the power (turning on the mains fuse or connecting the power cord to the power outlet).

1 INSTALLATION - BASICS

- Disconnect the installation supply voltage before installing the controller. Remember that any mounting works should be carried out when the mains voltage is disconnected (switch off the mains fuse or disconnect the power cord from the mains socket).

CONNECTION DIAGRAMS

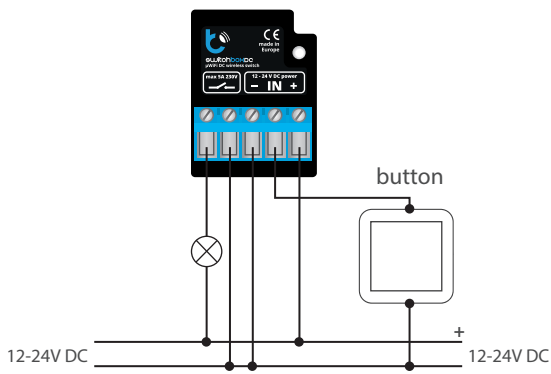
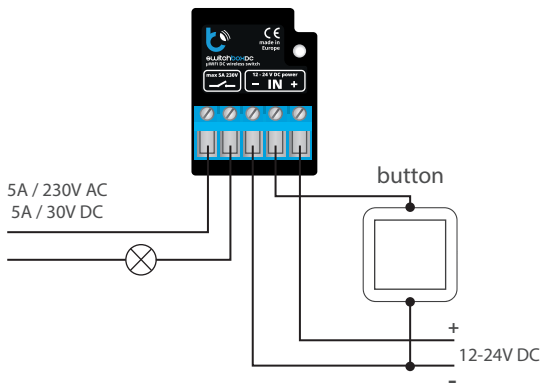

2 FIRST START

- Download the **free wBox application**. If you have an Android mobile device, you will find the application in the Play Store. For iOS devices the application is in the App Store.
- By using your mobile phone or tablet, connect it to the device wireless network. To do this, enter to your smartphone or tablet settings, then go to setting of the WiFi network and find the network name „switchBoxDC-xxxxxxx“ where xxxxxxxx is the serial number of the device. Connect to this network.
- Open the wBox application. A device will appear at the top of the screen. To add it to the application, click on "+" on the right side of the name. To pre-configure the controller, click on the default device name.



You can also set the configuration using the web browser of your phone / tablet. After connecting to the wireless network of the controller, turn on the browser and go website www.blebox.eu

- Test the work of the controller, by clicking the ON / OFF button, paying attention to the behavior of the connected load. If you have connected a wall push-button, check its work. In the default configuration of the controller, for a mono-stable push-button, holding down the push-button should cause that the load turn on, releasing the pushbutton will turn off the load. To



change this behavior, go to the "Settings" (icon at the top-right corner of the screen) and then select "Set actions triggered by input", for the corresponding action select the appropriate action type for the given trigger. You can configure 10 actions for a push-button. For example, to switch on / off the lighting each time you press the button, select the action type as "Toggle state" and as trigger select "Short click".

- Also check the selection in the "State after restart" option, which determines how the controller behaves after a restart caused by, for example, a power failure. You can choose whether the load should be on, off, remain as before the restart (if it was off then it has to continue off), or take the opposite state.

3 ACCESS POINT AND WIFI NETWORK SETTINGS

- Once you turn on the controller for the first time, you can proceed to its further configuration. Being connected to the WiFi network emitted by the device, in the control panel of the wBox application select the device, then go to "Settings" (icon at the top-right corner of the screen).
- You can change the name of the device that is displayed in the wBox application. In addition, you can change the name and password of its generated WiFi network. Remember that changing the network name or password will disconnect the device immediately after you click the "Save" button, so reconnect to the device using the newly assigned network name and password.
- You can add the controller to your home WiFi network to control it through this home network or from anywhere in the World. To do this, in the "Connect" settings section, select a network name from the list and press "Connect". If is required, enter the WiFi network password. During the connection of the controller to your home network, the phone / tablet may be disconnected from the network. In this case, you will need to reconnect your phone / tablet to the controller network.
- Please remember that in order to control the device outside the local WiFi network, from anyplace in the World by using the wBox application, the option "Remote access enabled" in the controller settings must be set to "Yes".
- Once you've finished configuring the WiFi network, you can disconnect your phone/tablet from the controller network and connect your mobile device directly to your home WiFi network. The control from the wBox application will work the same way as when the phone / tablet is connected to the controller network. If the user leaves the local network, for example, leaving home or using the mobile data, the wBox application will signal this state as "Remote mode". In this case, the devices can be controlled, but for security reasons settings are not available.

TECHNICAL SPECIFICATIONS

supply voltage	12/24V DC
energy consumption	< 1W
number of control outputs	1
type of control outputs	relay, isolated
maximum load	5A 230V AC 5A 30V DC
maximum power	1150 VA @ 230V AC (1150W for resistive load e.g. heater) 150W @ 30V DC
number of inputs	1
inputs type	low voltage, logical, push-button, short circuited to GND
supported switches	monostable (push-button), bistable (traditional, cross switch), not-illuminated
housing	made of polyurethane composition not containing halogens, self-extinguishing for thermal class B (130 °C)
protection level	IP20
dimensions	27 x 37 x 23 mm

transmission type	bi-directional, encrypted
radio frequency	2.4 GHz
communication standard	µWiFi, compatible with WiFi, 802.11g
mode	direct connection (as Access Point), Wi-Fi connection via a standard router, connection with access from any location in the world (requires only access to the Internet)
compatible devices and systems	Apple iPhone, Apple iPad, iPad Mini, Android, computers and mobile devices supporting HTML5

ADDITIONAL INFORMATION

LOCATION AND TIME OF THE DEVICE, SCHEDULE

The controller has the ability to work according to a given schedule. To make this possible, set the device's time. Go to settings in the "Device time" section, click "Change timezone". Then select your region and location from the list, confirm your selection clicking the "Save" button. The device will synchronize its time with the server time (if the controller is in a WiFi network with access to Internet) or it will download time from the phone / tablet. It is recommended that the controller is always connected to a WiFi network with Internet access so that it can automatically synchronize its clock.

To be able to control devices using the local sunrise and sunset, you must also select the location of the controller. You can specify the location of the device using a smartphone or tablet. In the section "Device location", click "Set locations". Browser will ask whether to share locations - allow. In the "Coordinates" field, should appear the approximate coordinates of your location. If the "Set locations" button blinks red with the word "Error", or the "Coordinates" field did not change the value from "Not set" to numeric data, a failure has occurred during the location download. You should make sure that the phone / tablet has a GPS module and that the sharing location service is enabled on the phone.

Adding schedule entries can be performed by clicking the "Add item" button in the "Schedule" section of settings. You can select the days in which the task will be performed, the type of entry (at a specific time, or relative to sunrise / sunset - only having a correctly set location) and set the parameters of the task. The set tasks will be visible as a list, individual entries can be edited or deleted.

SOFTWARE UPDATE

To update the software in the controller, connect it to your home WiFi network (see "Access Point and WiFi settings" section) which is connected to the Internet. Go to "Settings" (icon at the top-right corner of the screen) and click the "Get new firmware" button in the final section on settings. Wait about 1 minute, do not close the interface and don't perform other actions. The device will download the latest software. The software version number, hardware version and device identifier can be read at the bottom of the settings screen.

for more information visit our website
www.blebox.eu
 or send us an email to: info@blebox.eu
 support is available at support@blebox.eu

made in europe



proudly made by
blebox